

## Nimbus CS-3 Reverse Osmosis System



41840 McAlby Court, Suite A  
Murrieta, CA 92562  
800-451-9343, FAX 951-894-2801  
[www.nimbuswater.com](http://www.nimbuswater.com)

Congratulations on your purchase of the Nimbus CS-3 reverse osmosis system. When properly maintained, this system will provide you with years of trouble-free service. The next sections contain important information on the proper care and maintenance of your system, please take a few minutes to read through this information.

The cartridges in this system must be replaced on a regular basis to maintain efficiency and to safeguard water quality. These cartridges work together to remove potential contaminants from your tap water and must be replaced every 6-12 months. Any significant change in performance of the system should be investigated promptly to avoid secondary damage or deterioration to other parts of the system.

### Replacement Cartridges

Description	Replacement Interval
RO Membrane Desalinator	12 months
Pre-filters	6-12 months
Post-Filter	12 months
In-line Carbon Filter	12 months



### System Specifications

	Membrane	System w/Tank
Production	36 GPD (136.3 LPD)	11.3 GPD (42.8LPD)
TDS Rejection	95%	95%

*Tested at 60 psig (4 bar), 500ppm TDS municipal water, 77°F (25°C)*

### Feed Water Requirements

Pressure	40-80 psi (275 kPa - 552 kPa)
Temperature	40°F - 100°F (4°C - 38°C)
TDS	<2000 mg/L
Chlorine	<1.0 mg/L
NTU	<1
SDI	<5
pH	4-8

*Feed water must be potable, municipal water. Must be free of potential membrane foulants such as Iron, Hydrogen Sulfide and Manganese.*



The Limited Warranty extends to the original purchaser of the system. This warranty covers all parts and factory labor needed to repair any Manufacturer-supplied item that proves to be defective in material, workmanship or factory preparation. The above-mentioned warranty applies for the first full calendar year from date of purchase. These defective items are subject to the following exclusions: membranes, filters, O-rings, and all other parts or components that require regular replacement as a result of ordinary usage.

**Disclaimers** This Warranty applies only if the system is installed and used in compliance with the instructions enclosed with the system.

This Warranty does not cover the costs of repairs or adjustments to the unit that may be needed because of the use of improper parts, equipment or materials. This Warranty does not cover repairs required due to unauthorized alterations of the unit, or failure of a unit caused by such alterations or by unauthorized repairs.

The Warranty does not cover malfunctions of the unit due to tampering, misuse, alteration, lack of regular maintenance, misapplication, fouling due to hydrogen sulfide or iron, scaling from excessive hardness, turbidity greater than 1.0 NTU, Silt Density Index (SDI) greater than 5.0 SDI, or excessive membrane hydrolysis due to chlorine levels in excess of 0.5 ppm. In addition, damage to the unit due to fire, accident, negligence, act of God, or events beyond the control of the Manufacturer are not covered by this warranty.

**Incidental and Consequential Damages** The Manufacturer does not assume responsibility for payment of incidental and consequential damages as a result of the failure of this unit to comply with express or implied warranties, such as lost time, inconvenience, damage to personal property, loss of revenue, commercial losses, postage, travel, telephone expenditures, or other losses of this nature. Some states do not allow the exclusion or limitation of incidental or consequential damages, so this exclusion may not apply to you.

**Owner's Warranty Responsibilities** Under the provisions of the Warranty, the owner is expected to schedule maintenance, as described in this Manual. Neglect, improper maintenance, abuse, or unapproved modifications may invalidate the Warranty. Should your unit develop a defect or otherwise fail to perform in accordance with this warranty, you should contact the dealer from whom the product was originally purchased.

**Implied Warranties** The implied at-law warranties of merchantability and fitness for a particular purpose shall terminate on the date one year after the date of purchase. Note: some states do not allow limitations on how long an implied warranty lasts, so the above limitations may not apply to you.

**Other Rights** This Warranty gives you specific legal rights and you may also have other rights which vary from state to state.

Please fill out the form below and retain for future reference.

Model: Nimbus CS-3

Date Code: \_\_\_\_\_

Install Date: \_\_\_\_\_

Sold by: \_\_\_\_\_

Installed By: \_\_\_\_\_

Service Center  
Phone Number: \_\_\_\_\_

# Nimbus

WATER SYSTEMS

## Typical Installation Diagram

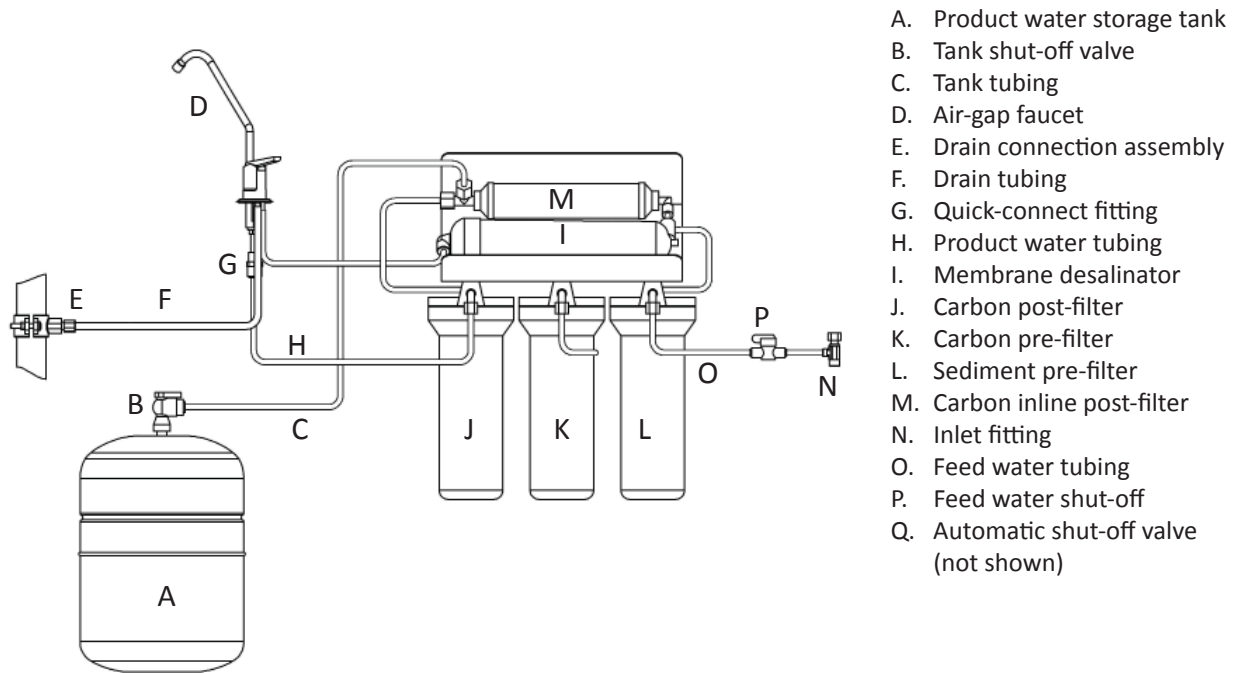

- A. Product water storage tank
- B. Tank shut-off valve
- C. Tank tubing
- D. Air-gap faucet
- E. Drain connection assembly
- F. Drain tubing
- G. Quick-connect fitting
- H. Product water tubing
- I. Membrane desalinator
- J. Carbon post-filter
- K. Carbon pre-filter
- L. Sediment pre-filter
- M. Carbon inline post-filter
- N. Inlet fitting
- O. Feed water tubing
- P. Feed water shut-off
- Q. Automatic shut-off valve (not shown)

*This system has been designed for installation by a licensed professional such as a contractor or plumber. Proper completion of this installation will require basic familiarity with standard sink plumbing and proper use of common hand and power tools. Improperly installed systems could result in water damage due to leaks or flooding. Do not use with water that is microbiologically unsafe.*

# Nimbus WATER SYSTEMS CS-3 Push Handle Faucet

*For easier installation, attach all tubing prior to mounting the faucet.*

1. Insert polished faucet base onto base of faucet.
2. Push the 1/4" drain tubing onto the 1/4" barb fitting. This tube must be of sufficient length to reach the white swivel with yellow collet on the membrane desalinators.
3. Push the 3/8" tubing onto the larger 3/8" barbed fitting, being sure you have enough tubing to reach the drain saddle.
4. Slip the 1/4" and 3/8" tubing through opening in polished faucet base. Slide white plastic spacer open-end-up onto the threaded faucet stem (2).
5. Thread the 3/8" washer (3) and mounting lock nut (4) onto the threaded stem. (Fig 6)
6. Thread faucet quick-connect adapter (5) on to threads of faucet stem. NOTE: This connection should be hand-tightened only. Push one end of product tubing into connection.
7. Insert tubing and faucet assembly down through the sink hole.
8. Position the faucet to the desired handle orientation. Slip the slotted washer (1) between the white plastic spacer and the sink. Securely hand tighten the mounting nut.
9. Connect the 3/8" tubing to the drain saddle assembly using the drain connector nut supplied. This tubing should follow as direct a path as possible; long runs, looping or deep sags will restrict normal brine flow to the drain. Save the unused portion of the tubing for the installation of the storage tank.
10. Apply a small amount of silicone-based lubricant to the O-rings located at the base of the spout. Firmly insert spout assembly into the top hole of faucet body (approximately 1/4"). You may swivel the faucet left or right.

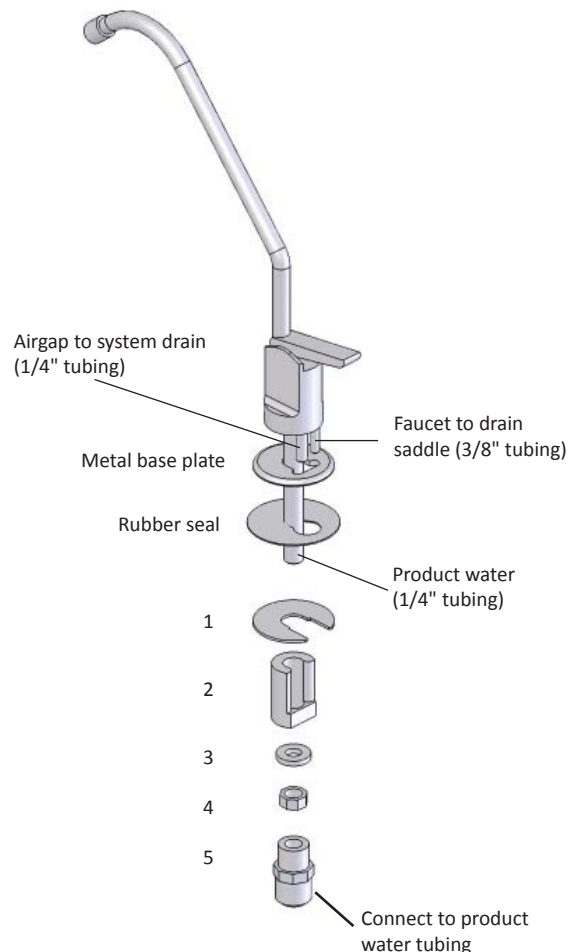

### Feed Connection

1. Locate and turn off the angle stop valve on the cold water line feeding the sink where the system is to be installed. This valve will usually be located under the sink on the pipe coming out of the wall.
2. When the angle stop valve is closed, relieve pressure in the line by opening the cold water tap on the sink.
3. To install the feed adapter at the faucet connector, disconnect the cold water feed line where it connects to the faucet inlet connector. This will usually require an open end wrench, pliers, or long reach faucet wrench.
4. Take the 1/4" feed connector from the parts kit and install it into the brass feed connector adapter. Use a crescent wrench or open-end wrench to tighten the connector into the adapter. See Fig. 2.
5. Using the flat and cone washers as necessary, install the feed adapter into the faucet inlet connector. Then reconnect the cold water feed line to the open end of the feed adapter. Tighten all connections securely.
6. Using the 1/4" tubing, install the compression nut, plastic ferrule, and plastic tube insert. Secure the tubing into the feed connector. Tighten the tubing retaining nut securely.
7. Obtain the small feed valve warning tag from the parts bag and attach it by its wire ties to the feed valve.

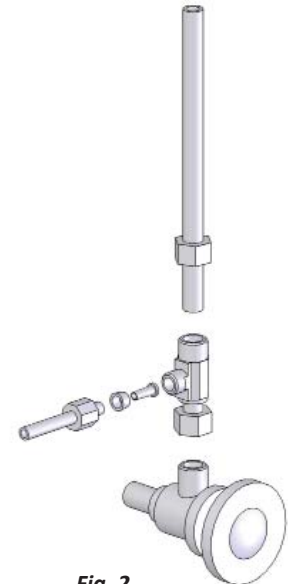

Fig. 2

### Drain Connection

*Note: The drain saddle assembly must be installed before the 'P' trap. Do not install the drain saddle assembly between the 'P' trap and the wall.*

1. Position drain saddle assembly (Fig. 3) on drain pipe under sink between the P trap and the sink connection.
2. Orient the drain saddle so that the connector opening points in the general direction of the planned location for the R.O. dispensing faucet.
3. Screw the connector nut onto the drain saddle threaded connector loosely (Fig. 4). Using the connector opening in the side of the drain saddle as a guide, drill a 3/8" hole through the wall of the drain pipe.
4. Remove drain saddle assembly. Place the adhesive foam pad over the 3/8" hole in the drain pipe. Replace the assembly onto the drain pipe, aligning the hole in the drain with the hole in the drain assembly.
5. Tighten the saddle bolts evenly on both sides until the saddle grips the pipe snugly - do not overtighten. (Fig.4)

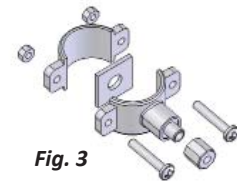

Fig. 3

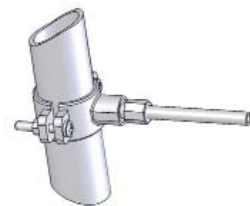
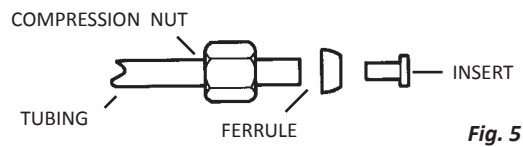

Fig. 4

1. Measure and cut a length of tubing 1/4" tubing long enough to reach from the faucet to the faucet connector on the system. Connect one end to the faucet nipple using a jaco nut and plastic insert. Connect the other end to the faucet connection on the post-filter using a jaco nut and plastic insert.
2. Measure and cut the length of 1/4" tubing long enough to reach from the feed water supply to the inlet. Connect the end to the feed inlet on the prefilter using a jaco nut and plastic insert. See Fig. 5.
3. Connect one end of a 3/8" length of tubing to the tank valve. Insert the other end firmly into the quick-connect cross on the shut-off valve.
4. Connect the 1/4" tubing from the faucet to the white swivel with yellow collet on the membrane desalinators.
5. Connect the free end of the 3/8" drain tubing to the drain connection.



**System Activation and Inspection**

1. Check all tubing connections to ensure they are firmly seated and secure.
2. Open the dispensing faucet at the sink. Close the tank shut-off valve.
3. Open the feed water valve to the system. Observe all tubing and connections for several minutes to detect any leaks. In approximately 5 minutes, (assuming normal feed water pressure) the dispensing faucet should begin dripping.
4. Place a pan or other temporary water basin near the drain 'P' trap. Loosen the connector nut holding the 3/8" tube in the drain saddle connector. Pull the tube out of the connector and use the pan to catch any water that may spill. Brine water should be flowing from the tube. Reconnect the tube to the drain saddle and hand-tighten the connector nut.
5. Allow the faucet the run for up to 15 minutes, then close the faucet.
6. Check for leaks at all connections.
7. Open the tank shut-off valve.

**Initial Flushing Procedure**

1. Before the system can be used for drinking water production it must be adequately flushed. Each reservoir tank is dosed with a small amount of powdered sanitizer before shipment, typically a chlorinating agent, in order to ensure tank internal cleanliness. Also, the carbon filter cartridge will release a small amount of carbon fines during the first tankful of flow. This flushing procedure will allow any sanitizer or carbon fines to pass from the system.
2. Initial tank filling will take approximately one hour (based on average feed pressure). When the tank is full, the water pressure will have risen to the point where the automatic shut-off valve inside the system will stop the feed flow through the system. Actuation of the automatic shut-off valve can be determined by either checking for a lack of brine flow to the drain saddle, or by listening very closely near the dispensing faucet for absence of water flow sound though the air gap. When the tank has filled for the first time, it should be left undisturbed for at least 8 hours to ensure proper sanitization.
3. After 8 hours has elapsed, open the dispensing faucet fully and allow the product water to run out to drain at maximum flow. The initial discharge will be dark with the bulk of the carbon particle wash out. There may also be the scent of chlorinated water from the sanitizing agent. When the flow has diminished to a fast drip or small stream, close the dispensing faucet.
4. Fill and flush the tank at least three times prior to use. If necessary, repeat until the chlorination scent has disappeared. It is important that the flush be done at maximum flow (e.g. the tank must be full) to assist in rapid wash out. After this flushing procedure the system is ready for normal use.

# Nimbus

WATER SYSTEMS

## CS-3 Installation Checklist

1. System is located where it will not be subject to physical impacts or rough contact by heavy objects.
2. Feed water pressure to the unit is no less than 40 psi and no greater than 80 PSI.
3. All tubing connections, especially push-in quick connections, are fully inserted.
4. Tubing connected between the faucet and the drain saddle fitting (the fitting attached to the sink drain pipe) runs "downhill" to the drain. There should be no loops or places where water would not flow out to the drain.
5. Feed water valve is open.
6. Within one to two hours after initial application of water pressure, check again for leaks especially at the tank, faucet tubing and connectors. These parts will not see full pressure until approximately 2 hours after the system is activated.
7. Flush three tankfuls of product water to drain. If a chlorine scent persists, repeat flushing procedure.

## Desalinator Replacement

1. Close the feed water shut-off valve and close the tank shut-off valve.
2. Open the dispensing faucet to relieve system pressure. Close dispensing faucet when flow has stopped.
3. Remove old desalinator from clips on frame. Install new desalinator on frame.
4. Remove feed tubing from old desalinator and insert it in the (green) feed connector of the new desalinator. See Figure 6.
5. Repeat tube removal and replacement steps for product and drain tubes.
6. Turn on feed water shut-off valve and open dispensing faucet.
7. Close dispensing faucet after water starts running.
8. Observe system for any leaks, especially at newly replaced cartridge.
9. Open the tank shut-off valve.
10. The system should be flushed at least once as described above under Section 8.

## Filter Replacement

1. Close the feed water shut-off valve and close the tank shut-off valve.
2. Open the dispensing faucet to relieve system pressure. Close dispensing faucet when flow has stopped.
3. Remove the prefilter housing by turning it clockwise (when viewed from above). Remove old prefilter from housing and discard. Remove O-ring from top of housing. Wash O-ring and housing. Replace O-ring in groove at top of housing. Insert new filter. Replace housing into cap by turning counter clockwise. (When viewed from above).
4. Repeat Step 5 for postfilter.
5. Turn on the feed water valve and open the tank shut-off valve.
6. Observe system for any leaks, especially at newly replaced cartridge.
7. The system should be flushed at least once as described in System Activation and Flushing.

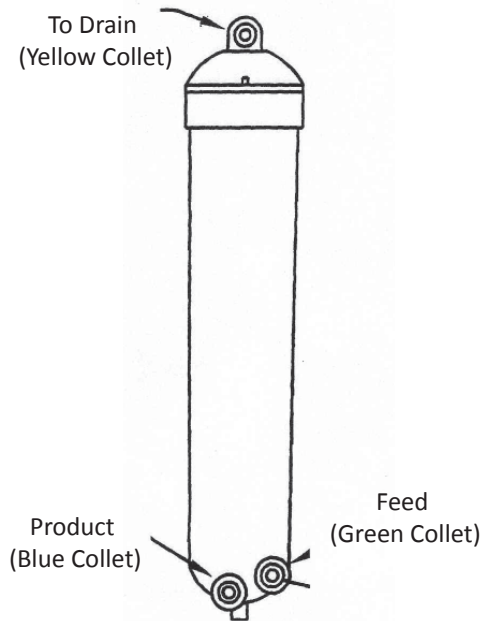

Fig. 6

**Horizontal Postfilter Replacement**

1. Close the feed water shut-off valve and close the tank shut-off valve.
2. Open the dispensing faucet to relieve system pressure. Close dispensing faucet when flow has stopped.
3. Locate the inline filter behind the membrane desalinators. Remove the fittings from the filter by using a wrench on the unscrew the fittings from the filter.
4. To install the new filter, first apply three wraps of teflon tape to the threads on the fittings, then reverse the above steps.
5. Turn on feed water shut-off valve and open dispensing faucet.
6. Close dispensing faucet after water starts running.
7. Observe system for any leaks, especially at newly replaced cartridge.
8. Open the tank shut-off valve.
9. The system should be flushed at least once as described in the previous section - Activation and Flushing.